

PANORAM

UFO HIGH BAY LIGHT

HV SERIES

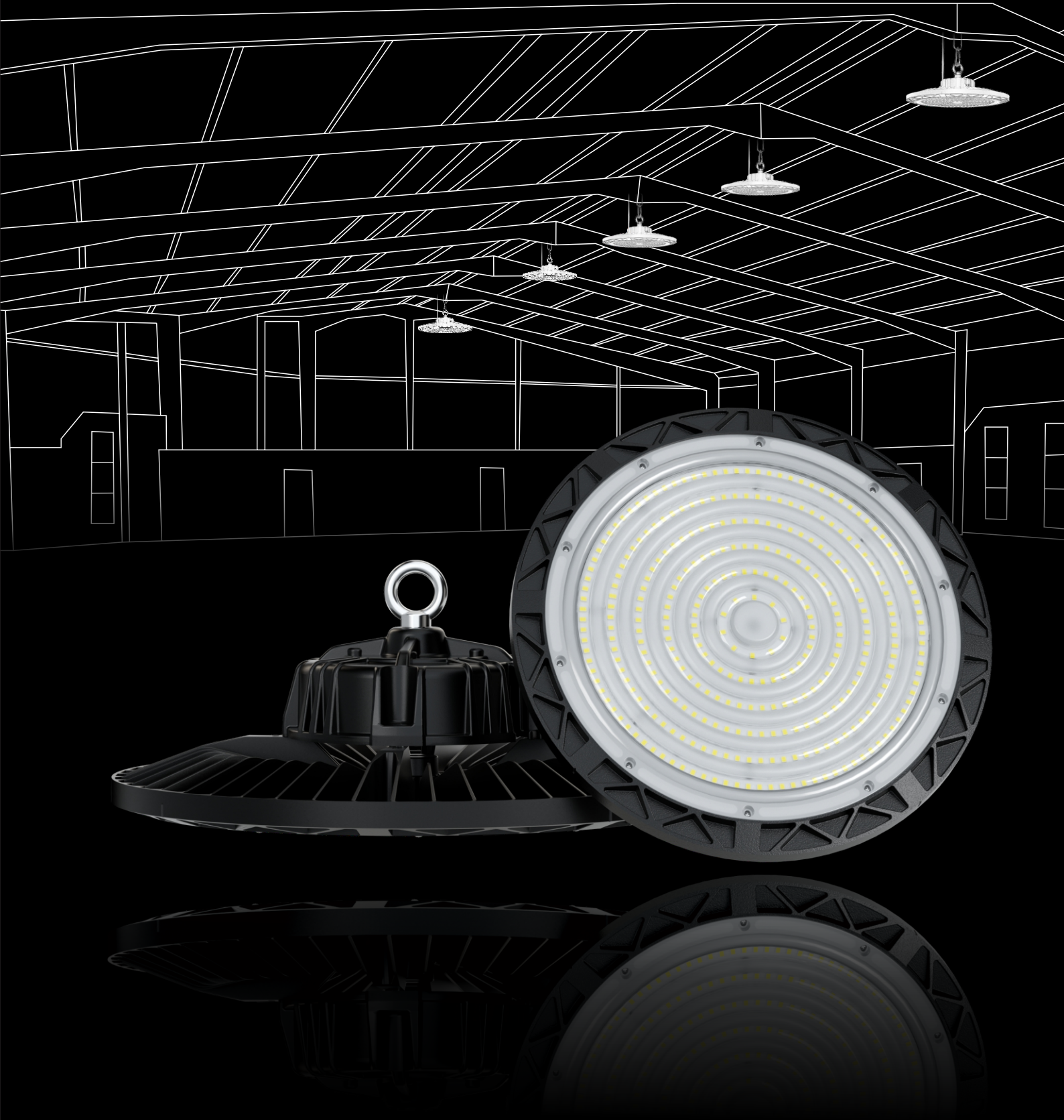

OVERVIEW



THERMAL MANAGEMENT

Structure is optimized by advanced FEA technology. Achieving longer lifespan at best cost-efficiency.

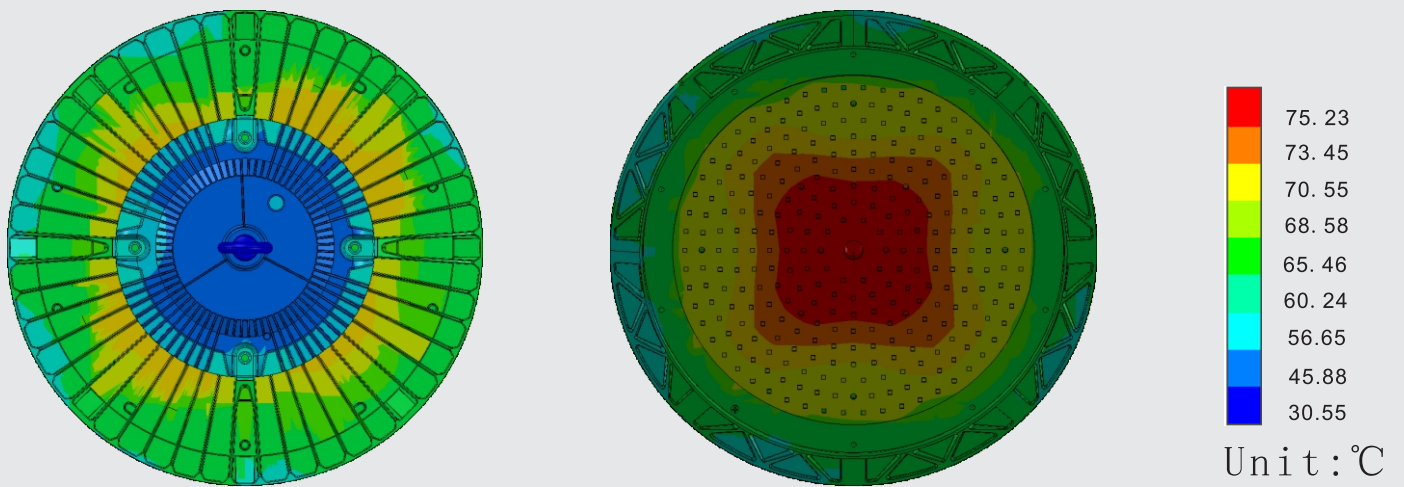

Thermal Conductivity(back)

Thermal Conductivity(front)

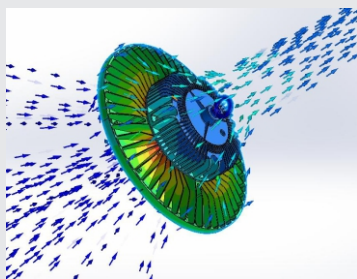

Thermal Air Convection

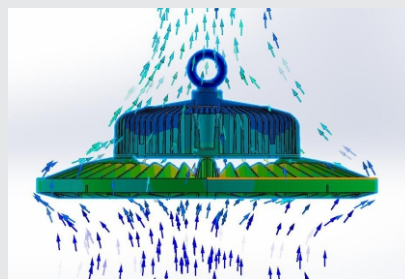

Thermal Air Convection

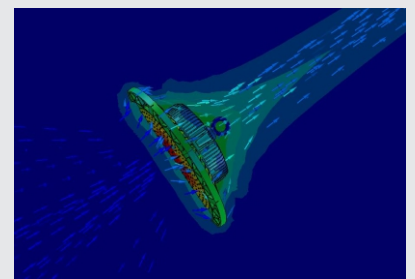

Thermal Air Flow

EXPLODED

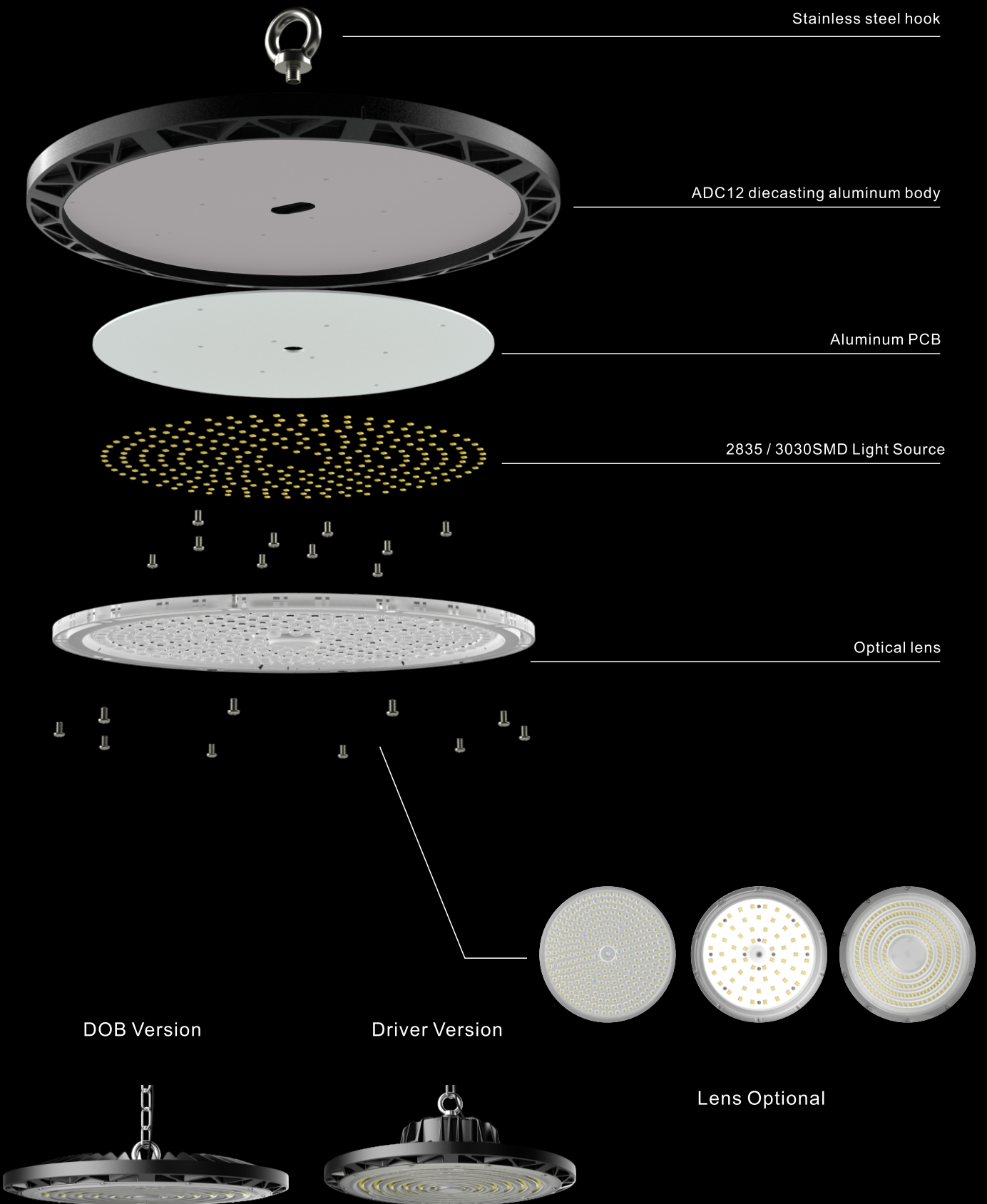

APPLICATIONS

Suitable for warehouse, sports centers, logistic centers, supermarkets, train stations and other similar indoor and outdoor locations.



INSTALLATION

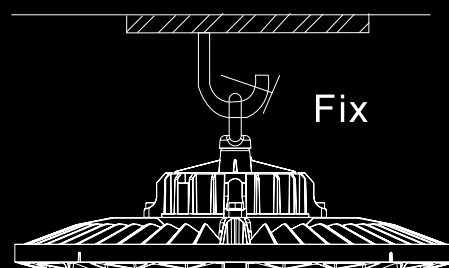
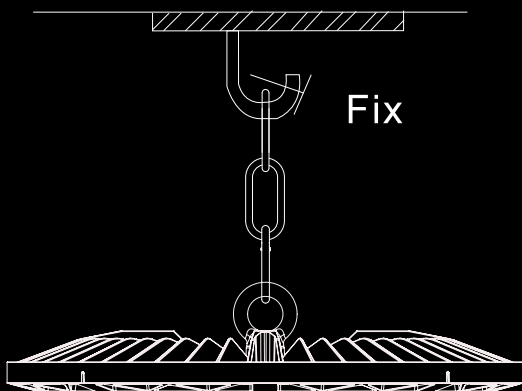

OPTICS

Tech. Support: Tell us the room length, width, height and the usage. We have an engineer team to respond the DIALUX simulations for lights quantity calculation and effects.

.ies files are available upon request.

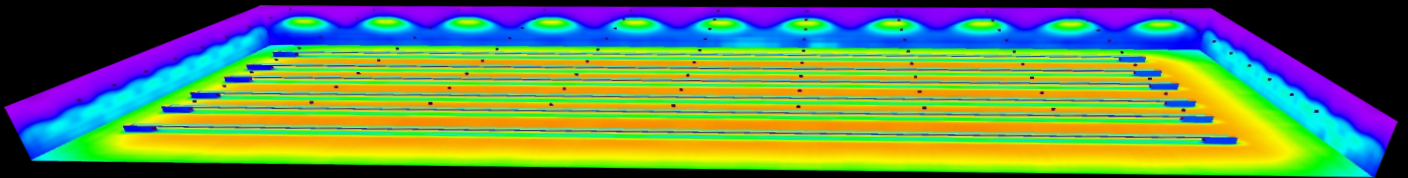
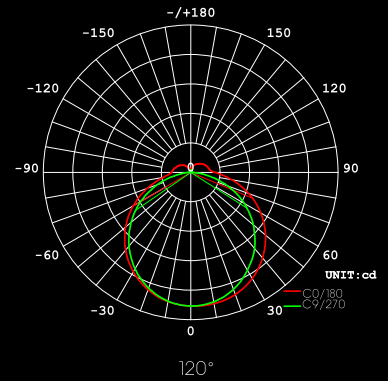
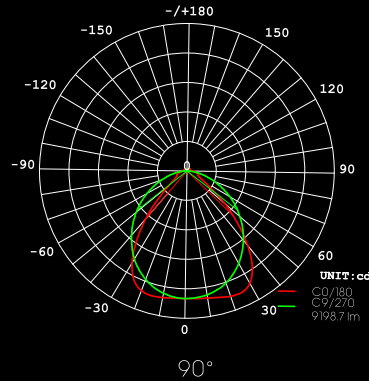

ELECTRICAL



Constant Current Solutions.

1. AC110-265V/200-265V 50/60Hz.
2. PF>0.95, THD comply with LVD/EMC.
3. Low THD:LVD+EMC.
4. Surge protection 10KV(4KV).
5. Efficiency>90%.
6. Start time 0.75S.

4KV SURGE PROTECTION

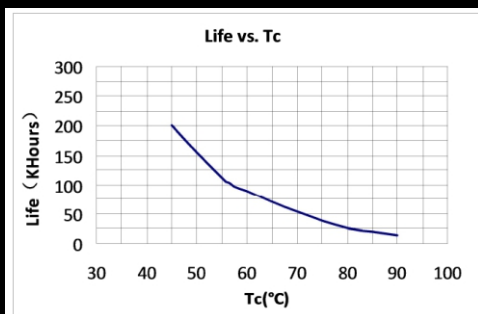

Brown: L
 Blue: N
 Yellow & Green: GND



DRIVER VERSIONS

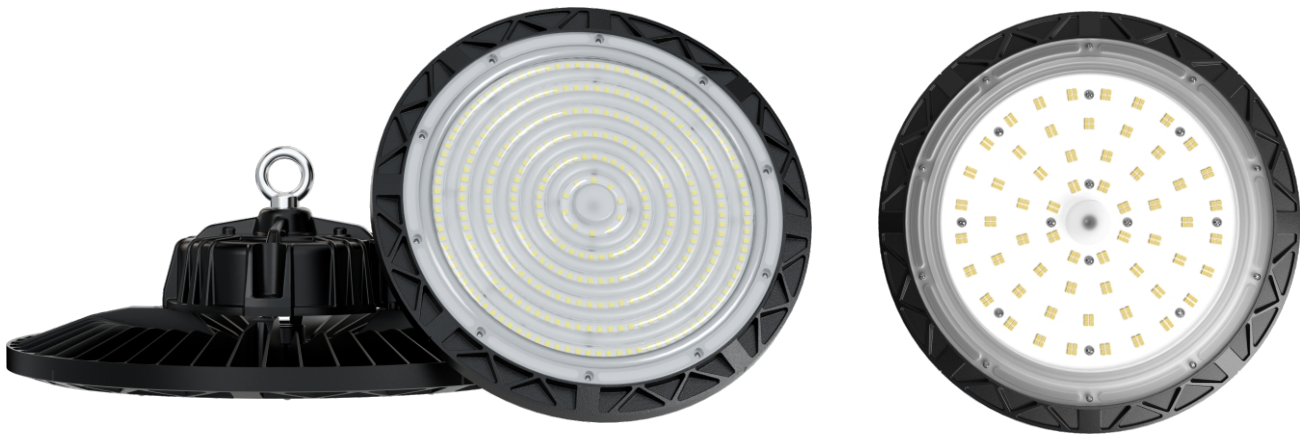

MAIN PARAMETERS

Model	P-HV100-100W	P-HV150-150W	P-HV200-200W
Body Size	Φ260xH100mm	Φ310xH100mm	Φ345xH105mm
LED Power	100W	150W	200W
Chip Type	SMD2835/3030	SMD2835/3030	SMD2835/3030
CCT	3000K/4000K/6500K	3000K/4000K/6500K	3000K/4000K/6500K
CRI	70/80	70/80	70/80
Beam Angle	90°/120°	90°/120°	90°/120°
Power Factor	>0.95	>0.95	>0.95
IP Grade	IP65	IP65	IP65
Housing Color	Black	Black	Black
Material	Aluminum+PC Lens	Aluminum+PC Lens	Aluminum+PC Lens
Voltage	AC110-265V	AC110-265V	AC110-265V

PACKING&PACKAGING



Item	Inner box size	weight	QTY/CTN	Carton Size	CBM/Carton(m ³)
P-HV100	270x110x272mm	1.5KG/PCS	8	54x46x28.7cm	0.072
P-HV150	320x105x322mm	2.0KG/PCS	5	54.5x33.5x33.7cm	0.062
P-HV200	355x115x357mm	2.6KG/PCS	5	59.5x37x37.2cm	0.082

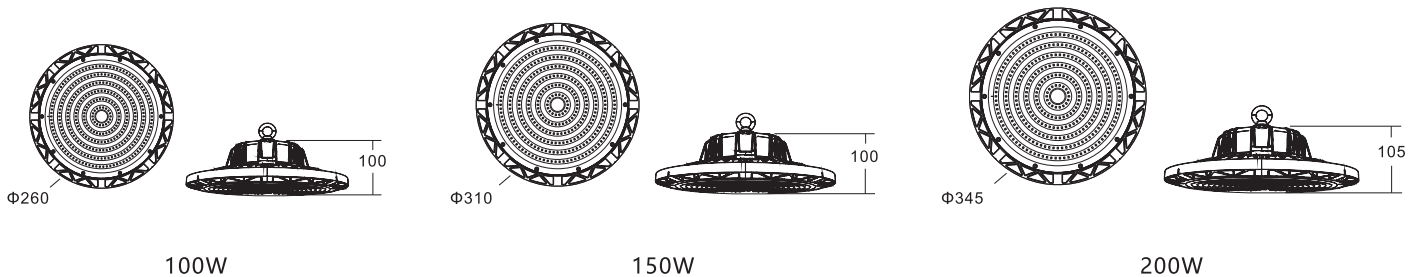

DOB VERSIONS



MAIN PARAMETERS

Model	P-HVD100-100W	P-HVD150-150W	P-HVD200-200W
Body Size	Φ270xH35mm	Φ310xH35mm	Φ345xH40mm
LED Power	100W	150W	200W
Chip Type	SMD2835/3030	SMD2835/3030	SMD2835/3030
CCT	3000K/4000K/6500K	3000K/4000K/6500K	3000K/4000K/6500K
CRI	70/80	70/80	70/80
Beam Angle	90°	90°	90°
Power Factor	>0.99/0.6	>0.99/0.6	>0.99/0.6
IP Grade	IP65	IP65	IP65
Housing Color	Black	Black	Black
Material	Aluminum+PC Lens	Aluminum+PC Lens	Aluminum+PC Lens
Voltage	AC200-265/110-265V	AC200-265/110-265V	AC200-265/110-265V

PACKING&PACKAGING



Item	Inner box size	weight	QTY/CTN	Carton Size	CBM/Carton(m ³)
P-HVD100	275x270x43mm	1.1KG/PCS	10	46x29x28.5cm	0.037
P-HVD150	325x320x43mm	1.5KG/PCS	10	46x34x33.5cm	0.051
P-HVD200	360x355x48mm	1.9KG/PCS	5	37.5x26x37cm	0.026

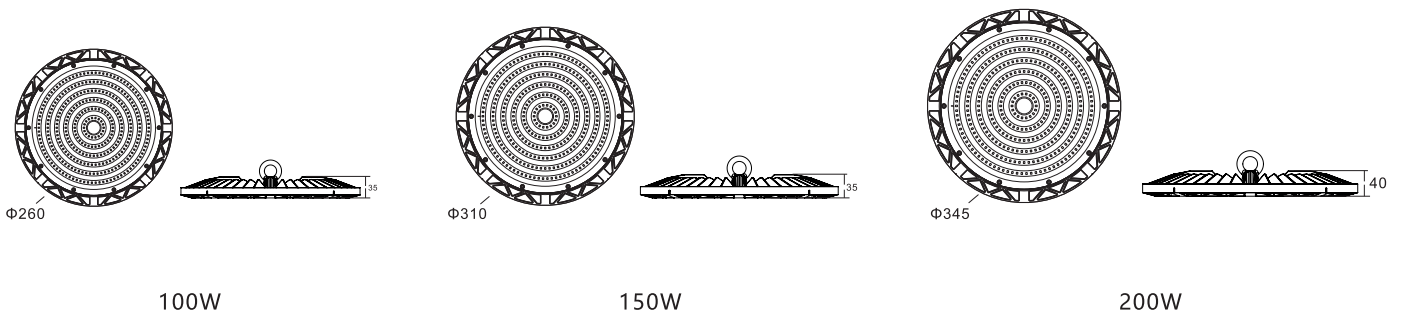

100W

150W

200W



Features

1. AC110-265V/200-265V 50/60Hz.
2. Lighting efficacy up to 100lm/W.
3. Famous brand 2835SMD light source.
4. PF>0.95, THD comply with LVD / EMC.
6. Die-casting aluminum body.
- Anti-corrosion powder painting.
7. IP65 Waterproof for outdoor use.
8. 3 years warranty.
9. Export certificates are available.

CAUTIONS:

1. Installation must be done by professional electricians. .
2. Do NOT take apart the product. It may be dangerous.
3. Do NOT stare at the light with naked eyes. It is harmful to eyes.
4. For outdoor lighting, waterproof measurements must be done to the cable terminals.

WARRANTY:

1. All UFO High Bay Lights are warranted by the manufacturer to be free of defects in material and workmanship for 3 years.
2. Warranty becomes void if the products is modified, improperly installed or used, damaged by accident or neglect, or if any parts are improperly installed or replaced by the user,
3. During the period of warranty time, if some products of us fails during normal circumstances and applications or have any defects above defined, we shall at our own choice replace or repair the defective products at no charge. And the liability claims would NOT exceed the value of the product itself.

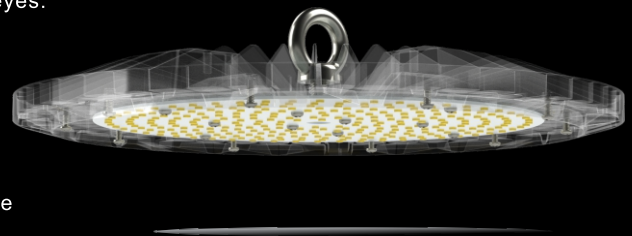

PANORAMA LIGHTING CO.,LTD

E-mail: admin@panorama-led.com

[Http://www.panorama-led.com](http://www.panorama-led.com)

Add.: 5F-12B, KeYuan East Rd, JiangHai District, Jiangmen City, Guangdong Province, P.R.China.



Jane

+86-18676275645



Alyssa

+86-13925326903



Lillian

+86-13169883399